

TRUSS BEAM 2 (poids 15 kg)

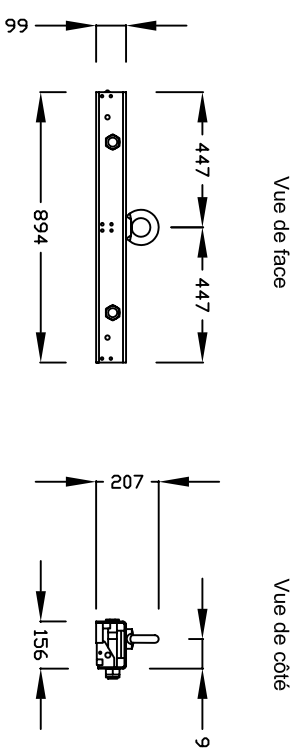

TRUSS BEAM 3 (poids 30 kg)

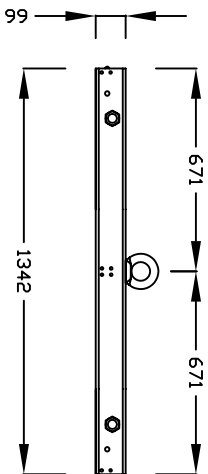

LITE FOOT W 2 (poids: 15 kg)

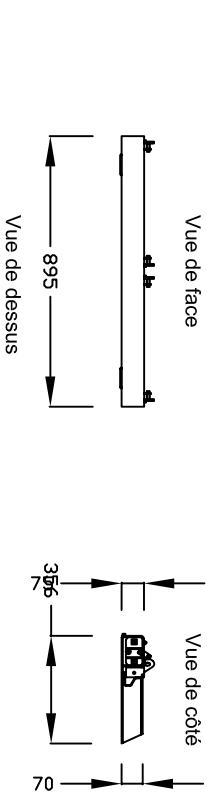

Autre dimension: lite FOOT W 3 long: 1350 mm (3 modules) poids 20 kg

LITE STACKER (poids: 7 kg)

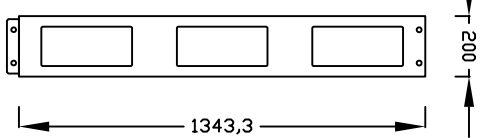

SKI (poids: 5 kg)

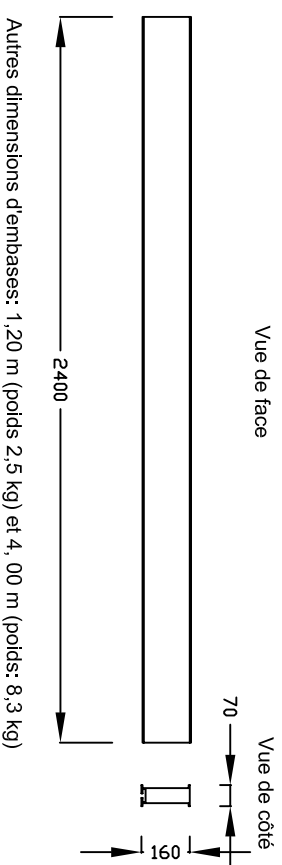

Autres dimensions d'embases: 1,20 m (poids 2,5 kg) et 4,00 m (poids: 8,3 kg)

8283 kg	2730 kg	2535 kg	2340 kg	2145 kg	1950 kg	1755 kg	1560 kg	1365 kg	1170 kg	975 kg	780 kg	585 kg	390 kg	195 kg
9000	8400	7800	7200	6600	6000	5400	4800	4200	3600	3000	2400	1800	1200	600
2730 kg	2548 kg	2366 kg	2184 kg	2002 kg	1820 kg	1638 kg	1456 kg	1274 kg	1092 kg	910 kg	728 kg	546 kg	364 kg	182 kg
8400	7840	7280	6720	6160	5600	5040	4480	3920	3360	2800	2240	1680	1120	560
2535 kg	2366 kg	2197 kg	2028 kg	1859 kg	1690 kg	1521 kg	1352 kg	1183 kg	1014 kg	845 kg	676 kg	507 kg	338 kg	169 kg
7800	7280	6760	6240	5720	5200	4680	4160	3640	3120	2600	2080	1560	1040	520
2340 kg	2184 kg	2028 kg	1872 kg	1716 kg	1560 kg	1404 kg	1248 kg	1092 kg	936 kg	780 kg	624 kg	468 kg	312 kg	156 kg
7200	6720	6240	5760	5280	4800	4320	3840	3360	2880	2400	1920	1440	960	480
2145 kg	2002 kg	1859 kg	1716 kg	1573 kg	1430 kg	1287 kg	1144 kg	1001 kg	858 kg	715 kg	572 kg	429 kg	286 kg	143 kg
6600	6160	5700	5280	4840	4400	3960	3520	3080	2640	2200	1760	1320	880	440
1950 kg	1820 kg	1690 kg	1560 kg	1430 kg	1300 kg	1170 kg	1040 kg	910 kg	780 kg	650 kg	520 kg	390 kg	260 kg	130 kg
6000	5600	5200	4800	4400	4000	3600	3200	2800	2400	2000	1600	1200	800	400
1755 kg	1638 kg	1521 kg	1404 kg	1287 kg	1170 kg	1053 kg	936 kg	819 kg	702 kg	585 kg	468 kg	351 kg	234 kg	117 kg
5400	5040	4680	4320	3960	3600	3240	2880	2520	2160	1800	1440	1080	720	360
1560 kg	1456 kg	1352 kg	1248 kg	1144 kg	1040 kg	936 kg	832 kg	728 kg	624 kg	520 kg	416 kg	312 kg	208 kg	104 kg
4800	4480	4160	3840	3520	3200	2880	2560	2240	1920	1600	1280	960	640	320
1365 kg	1274 kg	1183 kg	1092 kg	1001 kg	910 kg	819 kg	728 kg	637 kg	546 kg	455 kg	364 kg	273 kg	182 kg	91 kg
4200	3920	3640	3360	3080	2800	2520	2240	1960	1680	1400	1120	840	560	280
1170 kg	1092 kg	1014 kg	936 kg	858 kg	780 kg	702 kg	624 kg	546 kg	468 kg	390 kg	312 kg	234 kg	156 kg	78 kg
3600	3360	3120	2880	2640	2400	2160	1920	1680	1440	1200	960	720	480	240
975 kg	910 kg	845 kg	780 kg	715 kg	650 kg	585 kg	520 kg	455 kg	390 kg	325 kg	260 kg	195 kg	130 kg	65 kg
3000	2800	2600	2400	2200	2000	1800	1600	1400	1200	1000	800	600	400	200
780 kg	728 kg	676 kg	624 kg	572 kg	520 kg	468 kg	416 kg	364 kg	312 kg	260 kg	208 kg	156 kg	104 kg	52 kg
2400	2240	2080	1920	1760	1600	1440	1280	1120	960	800	640	480	320	160
1800	1680	1560	1440	1320	1200	1080	960	840	720	600	480	360	240	120
585 kg	546 kg	507 kg	468 kg	429 kg	390 kg	351 kg	312 kg	273 kg	234 kg	195 kg	156 kg	117 kg	78 kg	39 kg
390 kg	364 kg	338 kg	312 kg	286 kg	260 kg	234 kg	208 kg	182 kg	156 kg	130 kg	104 kg	78 kg	52 kg	26 kg
1200	1120	1040	960	880	800	720	640	560	480	400	320	240	160	80
195 kg	182 kg	169 kg	156 kg	143 kg	130 kg	117 kg	104 kg	91 kg	78 kg	65 kg	52 kg	39 kg	26 kg	13 kg
600	560	520	480	440	400	360	320	280	240	200	160	120	80	40

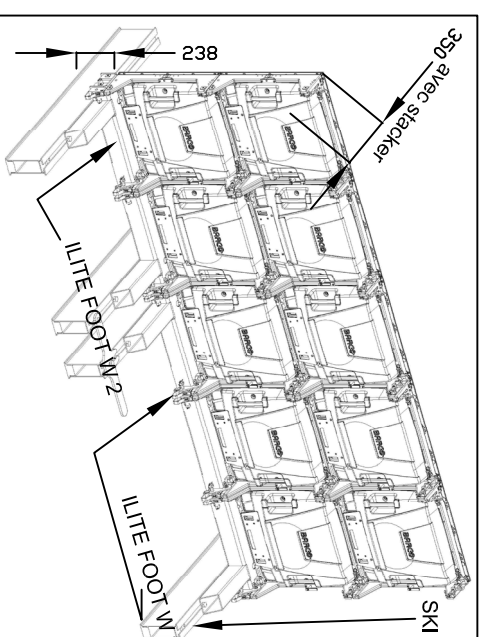
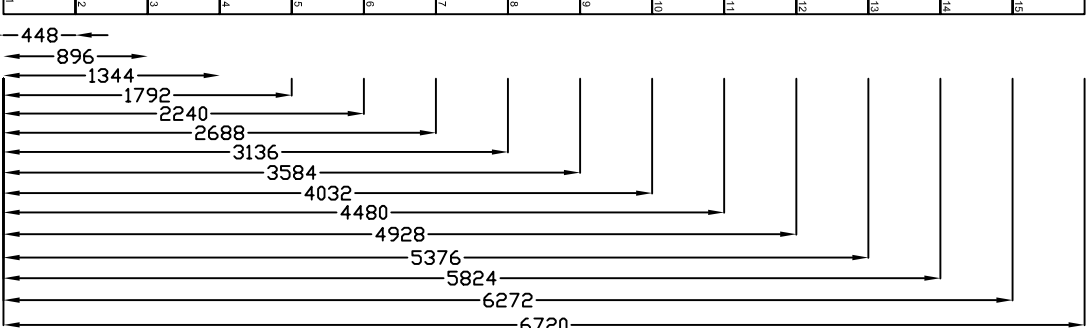
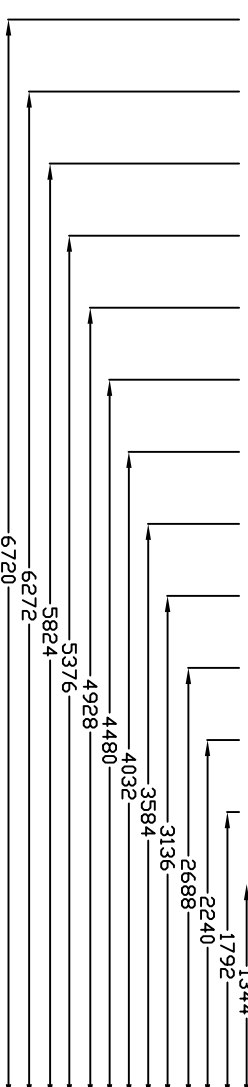

Maximum de modules posés: 12 lites de hauteur

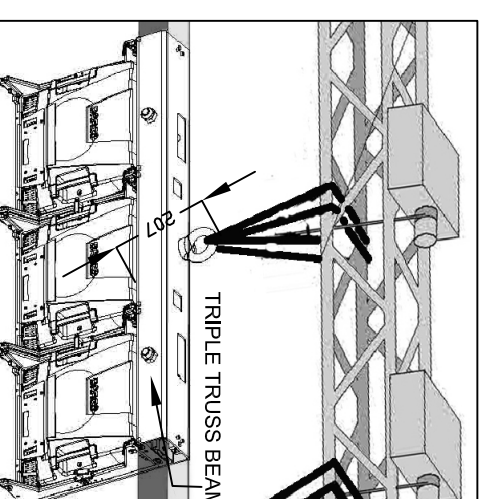

Maximum de modules suspendus: 15 lites x 15 lites

TILE (poids: 13 kg)

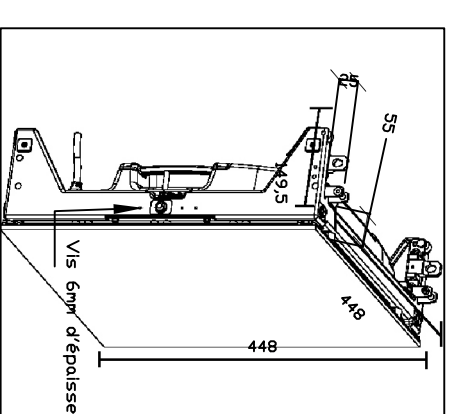

TRANSPORT:
6 modules per flight case
Poids d'un flight 132 kg

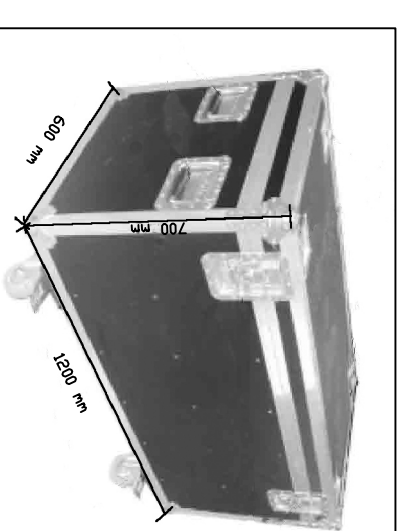

MATRICE

Zila Montjoie
1, rue des Drapiers
93210 La Plaine Saint Denis
Tel. +33 (0)1 55 93 48 48

SMD 6mm

12 juillet 2005

mm 1/25